

Contactors for Capacitor Switching

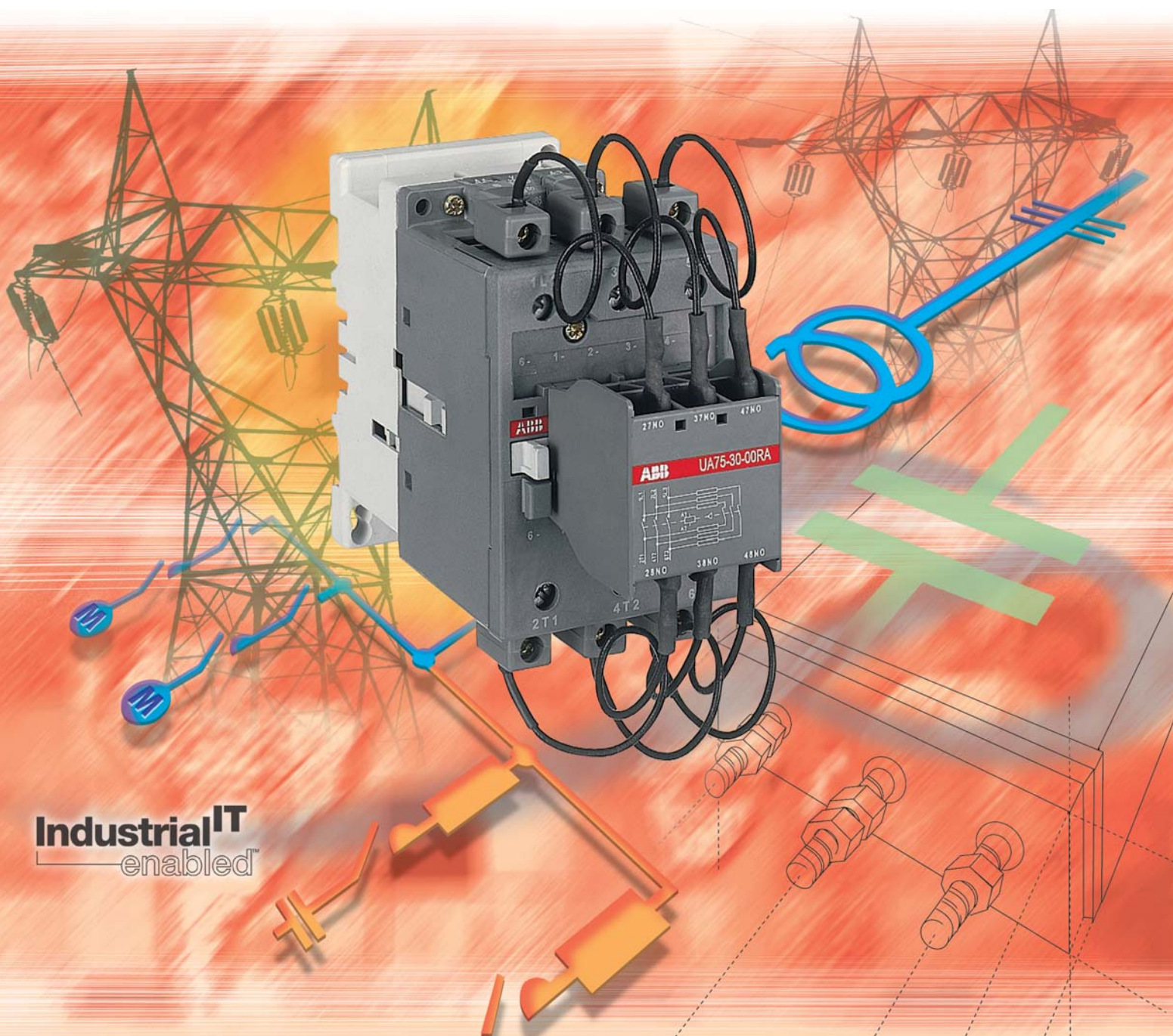

IndustrialIT
enabled™



Contents

General

Reminder of Capacitor Transient Conditions	2
Steady State Condition Data	2
Consequences for the Contactors	2

ABB Solutions for Capacitor Bank Switching

The UA..RA Contactors, equipped with Damping Resistors	3
The UA... Contactors	3
The A... and AF... Standard Contactors	3

UA..RA Contactors, equipped with Damping Resistors

Application	4
Description	4
Selection Table	4
Ordering Details	5
Technical Data	6
Main Accessories	7
Terminal Marking and Positioning	8
Dimensions	9

UA... Contactors

Application	10
Selection Table	10
Ordering Details	11
Technical Data	12
Main Accessories	13
Terminal Marking and Positioning	14
Dimensions	15

A... and AF... Standard Contactors

Application	16
Selection Table	16
Ordering Details	17
Main Accessories	18

Selection Examples

Application and possibilities	19
-------------------------------------	----

Calculation and Dimensioning

Inrush current peak and frequency - Inductances - Installation studies	20
--	----

Contactors for Capacitor Switching

AC-6b Utilization Category according to IEC 60947-4-1

Capacitor Transient Conditions

In Low Voltage industrial installations, capacitors are mainly used for reactive energy correction (raising the power factor). When these capacitors are energized, overcurrents of high amplitude and high frequencies (3 to 15 kHz) occur during the transient period (1 to 2 ms).

The amplitude of these current peaks, also known as "inrush current peaks", depends on the following factors:

- The network inductances.
- The transformer power and short-circuit voltage.
- The type of power factor correction.

There are 2 types of power factor correction: fixed or automatic.

Fixed power factor correction consists of inserting, in parallel on the network, a capacitor bank whose total power is provided by the assembly of capacitors of identical or different ratings.

The bank is energized by a contactor that simultaneously supplies all the capacitors (a single step).

The inrush current peak, in the case of fixed correction, can reach 30 times the nominal current of the capacitor bank.



Fixed power factor correction

An automatic power factor correction system, on the other hand, consists of several capacitor banks of identical or different ratings (several steps), energized separately according to the value of the power factor to be corrected.

An electronic device automatically determines the power of the steps to be energized and activates the relevant contactors.

The inrush current peak, in the case of automatic correction, depends on the power of the steps already on duty, and can reach 100 times the nominal current of the step to be energized.

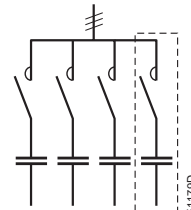

Automatic power factor correction

Steady State Condition Data

The presence of harmonics and the network's voltage tolerance lead to a current, estimated to be 1.3 times the nominal current I_n of the capacitor, permanently circulating in the circuit.

Taking into account the manufacturing tolerances, the exact power of a capacitor can reach 1.15 times its nominal power.

Standard IEC 60831-1 Edition 2002 specifies that the capacitor must therefore have a maximum thermal current I_T of:

$$I_T = 1.3 \times 1.15 \times I_n = 1.5 \times I_n$$

Consequences for the Contactors

To avoid malfunctions (welding of main poles, abnormal temperature rise, etc.), contactors for capacitor bank switching must be sized to withstand:

- **A permanent current that can reach 1.5 times the nominal current of the capacitor bank.**
- **The short but high peak current on pole closing** (maximum permissible peak current \hat{I}).

Contactors for Capacitor Switching

The ABB Solutions

ABB offers 3 contactor versions according to the value of the inrush current peak and the power of the capacitor bank.

UA..RA Contactors for Capacitor Switching (UA 16..RA to UA 75..RA) with insertion of damping resistors.

The insertion of damping resistors protects the contactor and the capacitor from the highest inrush currents.



UA... Contactors for Capacitor Switching (UA 16 to UA 110)

Maximum permissible peak current $\hat{I} \leq 100$ times the nominal rms current of the switched capacitor.



A... and AF... Standard Contactors (A 12 to A 300 and AF 400 to AF 750)

Maximum permissible peak current $\hat{I} \leq 30$ times the nominal rms current of the switched capacitor.



● In a given application, if the user does not know the value of the inrush current peak, this value can be approximately calculated using the formulas given on the pages "Calculation and dimensioning", or in the selection tools available on the ABB Website www.abb.com/lowvoltage left menu: "Interactive Tools" select: "Contactors: AC-6b Capacitor Switching".

UA..RA 3-pole Contactors for Capacitor Switching

Peak Current $\hat{I} \geq 100$ Times the rms Current



Application

The **UA..RA** contactors can be used in installations in which the peak current far exceeds 100 times nominal rms current. The contactors are delivered complete with their damping resistors and must be used without additional inductances (see table below). The capacitors must be discharged (maximum residual voltage at terminals ≤ 50 V) before being re-energized when the contactors are making. Their electrical durability is 250 000 operating cycles for $U_e < 500$ V and 100 000 operating cycles for $500 \text{ V} \leq U_e \leq 690$ V.

Description

The **UA..RA** contactors are fitted with a special front mounted block, which ensures the serial insertion of 3 damping resistors into the circuit to limit the current peak on energization of the capacitor bank. Their connection also ensures capacitor precharging in order to limit the second current peak occurring upon making of the main poles.

Operating principle

The front-mounted block mechanism of the **UA..RA** contactors ensures:

- early making of the auxiliary "PA" poles with respect to the main "PP" poles
- automatic return to the open position of the auxiliary "PA" poles after the power poles are made.

When the coil is energized, the early making auxiliary poles connect the capacitor to the network via the set of 3 resistors. The damping resistors attenuate the first current peak and the second inrush current when the main contacts begin to make. Once the power poles are in closed position, the auxiliary poles automatically break.

When the coil is de-energized, the main poles break ensuring the breaking of the capacitor bank. The contactor can then begin a new cycle.

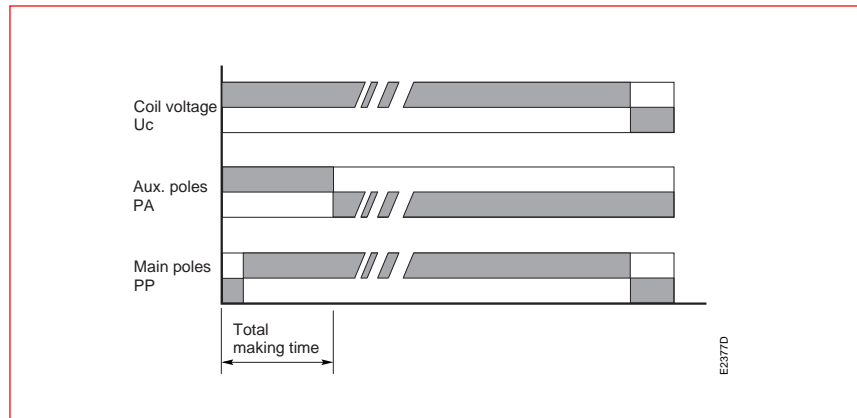
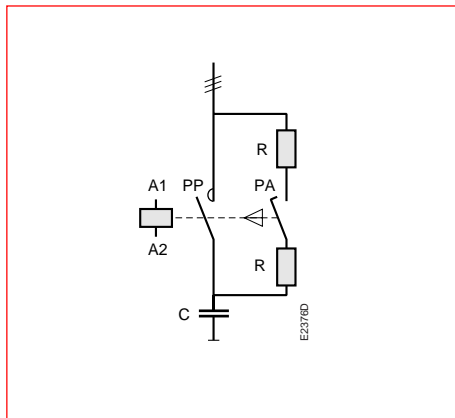

The insertion of resistors allows to damp the highest current peak of the capacitor when switching on, whatever its level.

Selection table

Type	Power in kvar – 50/60 Hz (AC-6b)															Max permissible peak current \hat{I}	gG type fuses max (*)
	230/240 V			400/415 V			440 V			500/550 V			690 V				
	40°C	55°C	70°C	40°C	55°C	70°C	40°C	55°C	70°C	40°C	55°C	70°C	40°C	55°C	70°C		
UA 16-30-10 RA	8	7.5	6	12.5	12.5	10	15	13	11	18	16	12.5	22	21	17	No limit	80
UA 26-30-10 RA	12.5	11.5	9	22	20	15.5	24	20	17	30	25	20	35	31	26		125
UA 30-30-10 RA	16	16	11	30	27.5	19.5	32	30	20.5	34	34	25	45	45	32		200
UA 50-30-00 RA	25	24	20	40	40	35	50	43	37	55	50	46	72	65	60		200
UA 63-30-00 RA	30	27	23	50	45	39	55	48	42.5	65	60	50	80	75	65		200
UA 75-30-00 RA	35	30	25	60	50	41	65	53	45	75	65	55	100	80	70		200

(*) The fuse ratings given in the column represent the maximum ratings ensuring type 1 co-ordination according to the definition of standard IEC 60947-4-1.

UA..RA 3-pole Contactors for Capacitor Switching

Peak Current $\hat{I} \geq 100$ Times the rms Current



UA 16-30-10 RA



UA 30-30-10 RA



UA 75-30-00 RA

Ordering Details

Power 400 V 40 °C kvar	Auxiliary contacts fitted	Type	Order code	Weight kg
		state coil voltage <input type="text"/> (see table below)	state coil voltage code <input type="text"/> <input type="text"/> (see table below)	Pack ^{ing} 1 piece
12.5	1 -	UA 16-30-10 RA <input type="text"/>	1SBL 181 024 R <input type="text"/> <input type="text"/> 10	0.460
22	1 -	UA 26-30-10 RA <input type="text"/>	1SBL 241 024 R <input type="text"/> <input type="text"/> 10	0.710
30	1 -	UA 30-30-10 RA <input type="text"/>	1SBL 281 024 R <input type="text"/> <input type="text"/> 10	0.810
40	- -	UA 50-30-00 RA <input type="text"/>	1SBL 351 024 R <input type="text"/> <input type="text"/> 00	1.350
50	- -	UA 63-30-00 RA <input type="text"/>	1SBL 371 024 R <input type="text"/> <input type="text"/> 00	1.350
60	- -	UA 75-30-00 RA <input type="text"/>	1SBL 411 024 R <input type="text"/> <input type="text"/> 00	1.350

Coil voltages and codes

Voltage <input type="text"/> V - 50Hz	Voltage <input type="text"/> V - 60Hz	Code <input type="text"/> <input type="text"/>
24	24	8 1
48	48	8 3
110	110 ... 120	8 4
220 ... 230	230 ... 240	8 0
230 ... 240	240 ... 260	8 8
380 ... 400	400 ... 415	8 5
400 ... 415	415 ... 440	8 6



Other voltages, consult page 0/1 of the main catalogue.

UA..RA 3-pole Contactors for Capacitor Switching

Peak Current $\hat{I} \geq 100$ Times the rms Current



Technical Data

Types	UA 16..RA	UA 26..RA	UA 30..RA	UA 50..RA UA 63..RA UA 75..RA
Short-circuit protection gG type fuses	sized 1.5 ... 1.8 I_n of the capacitor			
Max. electrical switching frequency cycles/h	240			
Electrical durability AC-6b				
– operating cycles at $U_e \leq 440$ V	250 000			
– operating cycles at $500 \text{ V} \leq U_e \leq 690$ V	100 000			
Connecting capacity (min. ... max.)				
Main conductors (poles)				
Rigid: solid ($\leq 4 \text{ mm}^2$)	1 x mm ²	1.5 ... 6	2.5 ... 16	6 ... 50
stranded ($\geq 6 \text{ mm}^2$)				
Flexible with cable end	1 x mm ²	1.5 ... 4	2.5 ... 10	6 ... 35
	2 x mm ²	–	2.5 ... 10 + 2.5 ... 4	6 ... 16 + 6 ... 10
Lugs	 L mm ≤ l mm >	7.7	10	–
		3.7	4.2	–
Auxiliary conductors (built-in auxiliary terminals + coil terminals)				
Rigid solid	1 x mm ²	1 ... 4		
	2 x mm ²	1 ... 4		
Flexible with cable end	1 x mm ²	0.75 ... 2.5		
	2 x mm ²	0.75 ... 2.5		
Lugs	 L mm ≤ l mm >	7.7	10	8
		3.7	4.2	3.7
Coil terminals	 L mm ≤ l mm >	8		
		3.7		
Degree of protection acc. to IEC 60947-1 / EN 60947-1 and IEC 60529 / EN 60529				
– Main terminals	IP 20		IP 10	
– Coil terminals	IP 20			
– Auxiliary terminals	IP 20			

Other technical characteristics are the same as those of standard A... contactors.  page 2/60 of the Main Catalogue.

UA..RA 3-pole Contactors for Capacitor Switching

Main Accessories



CA 5-10



CAL 5-11



RV 5/50



RC 5-1/50

Ordering Details

Auxiliary contact blocks

For contactors	Max. number of blocks	Contacts blocks	Type	Order code	Pack ^{ing} pieces	Weight kg
						1 piece

1-pole auxiliary contact blocks (Front mounting)

UA 30..RA	1 block	} 1 - - -	CA 5-10	1SBN 010 010 R1010	10	0.014	
UA 50..RA	2 blocks		CA 5-01	1SBN 010 010 R1001	10	0.014	
UA 63..RA	2 blocks						
UA 75..RA	2 blocks						

2-pole auxiliary contact blocks N.O. + N.C. (Side mounting)

UA 16..RA	1 block	} 1 1 - -	CAL 5-11	1SBN 010 020 R1011	2	0.050
UA 26..RA	2 blocks					
UA 30..RA	2 blocks					
UA 50..RA	2 blocks					
UA 63..RA	2 blocks					
UA 75..RA	2 blocks					

Surge suppressors for contactor coils

For contactors	Control voltage	Type	Order code	Pack ^{ing} pieces	Weight kg
	V a.c.				1 piece
UA 16..RA to UA 75..RA	24 ... 50	RV 5/50	1SBN 050 010 R1000	2	0.015
	50 ... 133	RV 5/133	1SBN 050 010 R1001	2	0.015
	110 ... 250	RV 5/250	1SBN 050 010 R1002	2	0.015
	250 ... 440	RV 5/440	1SBN 050 010 R1003	2	0.015
UA 16..RA to UA 30..RA	24 ... 50	RC 5-1/50	1SBN 050 100 R1000	2	0.012
	50 ... 133	RC 5-1/133	1SBN 050 100 R1001	2	0.012
	110 ... 250	RC 5-1/250	1SBN 050 100 R1002	2	0.012
UA 50..RA to UA 75..RA	250 ... 440	RC 5-1/440	1SBN 050 100 R1003	2	0.012
	24 ... 50	RC 5-2/50	1SBN 050 200 R1000	2	0.015
	50 ... 133	RC 5-2/133	1SBN 050 200 R1001	2	0.015
	110 ... 250	RC 5-2/250	1SBN 050 200 R1002	2	0.015
	250 ... 440	RC 5-2/440	1SBN 050 200 R1003	2	0.015

UA..RA 3-pole Contactors for Capacitor Switching

Peak Current $\hat{I} \geq 100$ Times the rms Current



Terminal Marking and Positioning

Standard devices without addition of auxiliary contacts

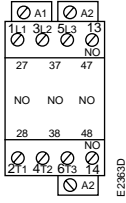

UA16-30-10 RA
UA26-30-10 RA

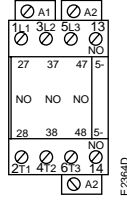

UA30-30-10 RA

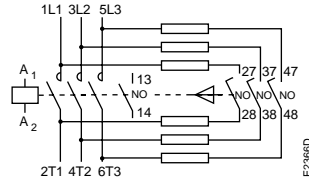

UA16 ... 30-30-10 RA

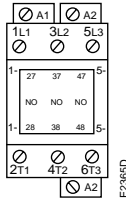

UA50 ... 75-30-00 RA

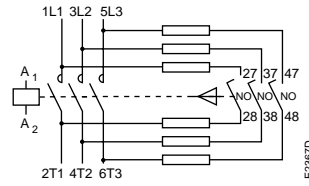

UA50 ... 75-30-00 RA

UA..RA 3-pole Contactors for Capacitor Switching

Peak Current $\hat{I} \geq 100$ Times the rms Current



Dimensions (mm)

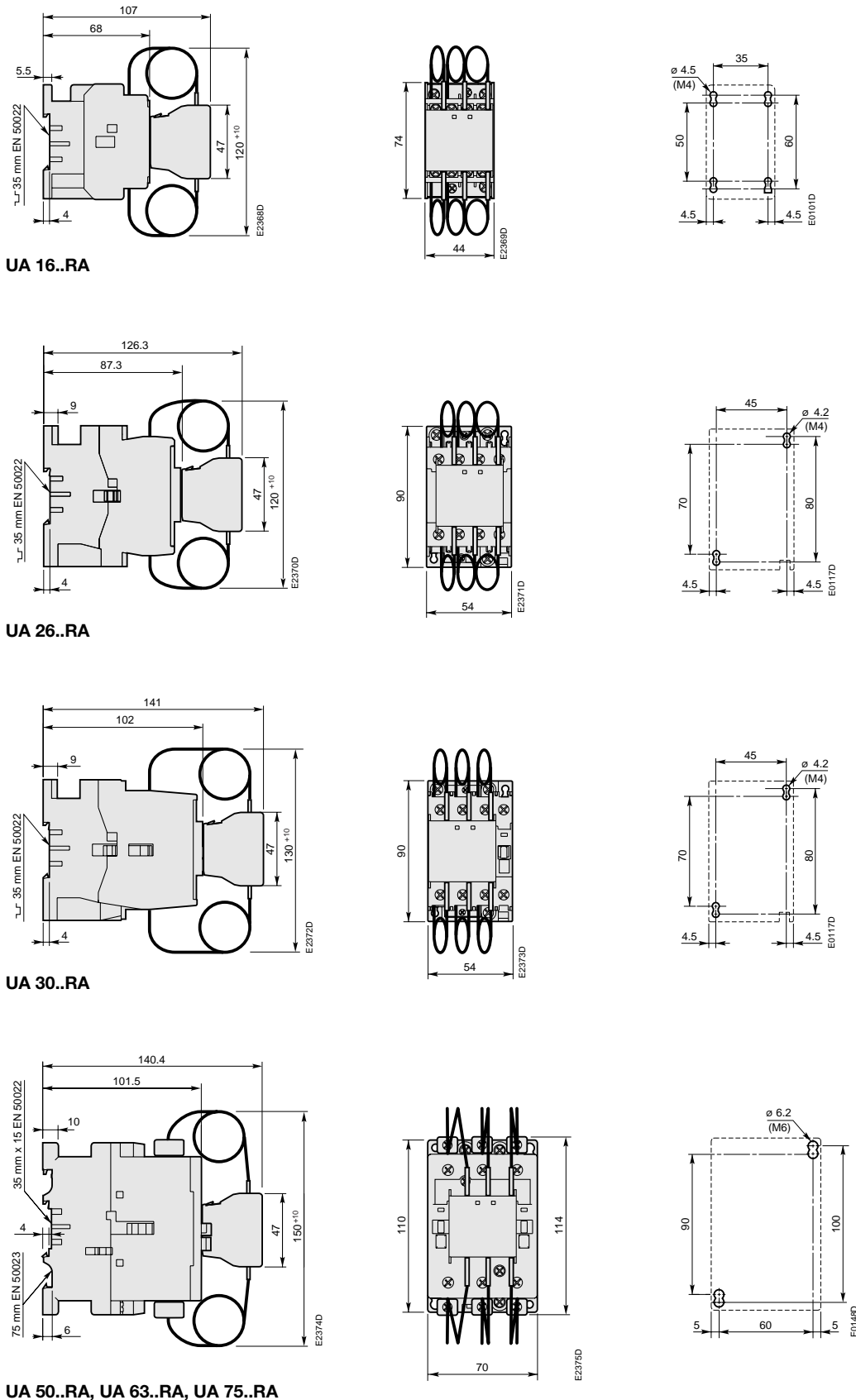

Detailed dimension drawings available in DXF and PDF formats.

UA... 3-pole Contactors for Capacitor Switching

Peak Current $\hat{I} \leq 100$ Times the rms Current



Application

The **UA...** contactors can be used for the switching of capacitor banks whose inrush current peaks are less than or equal to 100 times nominal rms current. The table below gives the permissible powers according to operational voltage and temperature close to the contactor. It also specifies the maximum peak current **\hat{I} values** accepted by the contactor.

The capacitors must be discharged (maximum residual voltage at terminals ≤ 50 V) before being re-energized when the contactors are making.

In these conditions, electrical durability of contactors is equal to 100 000 operating cycles.

Description

See general design for **A...** standard contactors. [☞ Main Catalogue.](#)

Selection Table

Type	Powers in kvar 50/60 Hz (AC - 6b)															Max. permissible peak current \hat{I} (kA)	
	230/240 V			400/415 V			440 V			500/550 V			690 V			U_e	U_e
	40 °C	55 °C	70 °C	40 °C	55 °C	70 °C	40 °C	55 °C	70 °C	40 °C	55 °C	70 °C	40 °C	55 °C	70 °C	≤ 500 V	> 500 V
UA 16	7.5	6.7	6	12.5	11.7	10	13.7	13	11	15.5	14.7	12.5	21.5	20	17	1.8	1.6
UA 26	12	11	8.5	20	18.5	14.5	22	20	16	22	22	19.5	30	30	25	3	2.7
UA 30	16	16	11	27.5	27.5	19	30	30	20	34	34	23.5	45	45	32	3.5	3.1
UA 50	20	20	19	33	33	32	36	36	35	40	40	40	55	55	52	5	4.5
UA 63	25	25	21	45	43	37	50	48	41	50	50	45	70	70	60	6.5	5.8
UA 75	30	30	22	50	50	39	55	53	43	62	62	47.5	75	75	65	7.5	6.75
UA 95	35	35	30	60/65*	60/65*	50/55*	65	65	55	70	70	60	80	80	70	9.3	8
UA 110	40	40	35	75	70/75*	65	75	75	70	80	80	75	90	90	85	10.5	9

(*) Use these values for $U_e = 415$ V

For **220 V** and **380 V**, multiply by **0.9** the rated values at 230 V and 400 V respectively.

Example: 50 kvar/400 V corresponding to $0.9 \times 50 = 45$ kvar/**380 V**.

If, in an application, the current peak is greater than the maximum peak current \hat{I} specified in the table above, select a higher rating, refer to the **UA..RA** contactors, or add inductances. [☞ "Calculation and Dimensioning"](#).

UA... 3-pole Contactors for Capacitor Switching

Peak Current $\hat{I} \leq 100$ Times the rms Current



UA 30-30-10



UA 50-30-00



UA 110-30-00

Ordering Details

Power 400 V 40 °C kvar	Max. peak current \hat{I} kA	Auxiliary contacts fitted	Type	Order code	Weight kg
			state coil voltage <input type="text"/> (see table below)	state coil voltage code <input type="text"/> <input type="text"/> (see table below)	Pack ^{ing} 1 piece
12.5	1.8	1 -	UA 16-30-10 <input type="text"/>	1SBL 181 022 R <input type="text"/> <input type="text"/> 10	0.340
20	3	1 -	UA 26-30-10 <input type="text"/>	1SBL 241 022 R <input type="text"/> <input type="text"/> 10	0.600
27.5	3.5	1 -	UA 30-30-10 <input type="text"/>	1SBL 281 022 R <input type="text"/> <input type="text"/> 10	0.710
33	5	- -	UA 50-30-00 <input type="text"/>	1SBL 351 022 R <input type="text"/> <input type="text"/> 00	1.160
		1 1	UA 50-30-11 <input type="text"/>	1SBL 351 022 R <input type="text"/> <input type="text"/> 11	1.200
45	6.5	- -	UA 63-30-00 <input type="text"/>	1SBL 371 022 R <input type="text"/> <input type="text"/> 00	1.160
		1 1	UA 63-30-11 <input type="text"/>	1SBL 371 022 R <input type="text"/> <input type="text"/> 11	1.200
50	7.5	- -	UA 75-30-00 <input type="text"/>	1SBL 411 022 R <input type="text"/> <input type="text"/> 00	1.160
		1 1	UA 75-30-11 <input type="text"/>	1SBL 411 022 R <input type="text"/> <input type="text"/> 11	1.200
60	9.3	- -	UA 95-30-00 <input type="text"/>	1SFL 431 022 R <input type="text"/> <input type="text"/> 00	2.000
		1 1	UA 95-30-11 <input type="text"/>	1SFL 431 022 R <input type="text"/> <input type="text"/> 11	2.040
75	10.5	- -	UA 110-30-00 <input type="text"/>	1SFL 451 022 R <input type="text"/> <input type="text"/> 00	2.000
		1 1	UA 110-30-11 <input type="text"/>	1SFL 451 022 R <input type="text"/> <input type="text"/> 11	2.040

Coil voltages and codes

Voltage <input type="text"/> V - 50Hz	Voltage <input type="text"/> V - 60Hz	Code <input type="text"/> <input type="text"/>
24	24	8 1
48	48	8 3
110	110 ... 120	8 4
220 ... 230	230 ... 240	8 0
230 ... 240	240 ... 260	8 8
380 ... 400	400 ... 415	8 5
400 ... 415	415 ... 440	8 6

Other voltages, consult page 0/1 of the main catalogue.

UA... 3-pole Contactors for Capacitor Switching

Peak Current $\hat{I} \leq 100$ Times the rms Current



Technical Data

Types	UA 16	UA 26	UA 30	UA 50 UA 63 UA 75	UA 95 UA 110
Short-circuit protection gG type fuses	sized 1.5 ... 1.8 I_n of the capacitor				
Electrical durability AC-6b operating cycles at $U_e \leq 690$ V	100 000				
Connecting capacity (min. ... max.) Main conductors (poles)					
Rigid: solid (≤ 4 mm ²) } 1 x mm ²	1 ... 4	1.5 ... 6	2.5 ... 16	6 ... 50	10 ... 95
stranded (≥ 6 mm ²) } 2 x mm ²	1 ... 4	1.5 ... 6	2.5 ... 16	6 ... 25	6 ... 35
Flexible with cable end 1 x mm ²	0.75 ... 2.5	0.75 ... 4	2.5 ... 10	6 ... 35	10 ... 70
2 x mm ²	0.75 ... 2.5	0.75 ... 4	2.5 ... 10	6 ... 16	6 ... 35
Lugs L mm \leq	7.7	10	–	–	30 (with LW110
I mm $>$	3.7	4.2	–	–	6 main catalogue)
Auxiliary conductors (built-in auxiliary terminals + coil terminals)					
Rigid solid 1 x mm ²	1 ... 4				0.75 ... 2.5
2 x mm ²	1 ... 4				0.75 ... 2.5
Flexible with cable end 1 x mm ²	0.75 ... 2.5			1 ... 2.5	0.75 ... 2.5
2 x mm ²	0.75 ... 2.5				
Lugs					
Built-in aux. terminals L mm \leq	7.7	10	8		
I mm $>$	3.7	4.2	3.7		
Coil terminals L mm \leq	8				
I mm $>$	3.7				
Degree of protection acc. to IEC 60947-1 / EN 60947-1 and IEC 60529 / EN 60529					
– Main terminals	IP 20			IP 10	
– Coil terminals	IP 20				
– Auxiliary terminals	IP 20			–	–

Other technical characteristics are the same as those of standard A... contactors. page 2/60 of the Main Catalogue.

UA... 3-pole Contactors for Capacitor Switching

Main Accessories



CA 5-10



CAL 5-11



RV 5/50



RC 5-1/50

Ordering Details

Auxiliary contact blocks (for other configurations and fitting details see Main Catalogue)

For contactors	Number of blocks	Contacts blocks	Type	Order code	Pack ^{ing} pieces	Weight kg										
						1 piece										
1-pole auxiliary contact blocks (Front mounting)																
UA 16 to UA 26	4 blocks	<table border="0"> <tr><td>{</td><td>1</td><td>-</td><td>-</td><td>-</td></tr> <tr><td></td><td>-</td><td>1</td><td>-</td><td>-</td></tr> </table>	{	1	-	-	-		-	1	-	-	CA 5-10	1SBN 010 010 R1010	10	0.014
{	1		-	-	-											
	-		1	-	-											
UA 30	5 blocks	CA 5-01	1SBN 010 010 R1001	10	0.014											
UA 50 to UA 110	6 blocks															
2-pole auxiliary contact blocks N.O. + N.C. (Side mounting)																
UA 16 to UA 75	2 blocks	1 1 - -	CAL 5-11	1SBN 010 020 R1011	2	0.050										
UA 95, UA 110	2 blocks	1 1 - -	CAL 18-11	1SFN 010 720 R1011	2	0.050										

Surge suppressors for contactor coils

For contactors	Control voltage	Type	Order code	Pack ^{ing} pieces	Weight kg
	V a.c.				1 piece
UA 16 to UA 110	24 ... 50	RV 5/50	1SBN 050 010 R1000	2	0.015
	50 ... 133	RV 5/133	1SBN 050 010 R1001	2	0.015
	110 ... 250	RV 5/250	1SBN 050 010 R1002	2	0.015
	250 ... 440	RV 5/440	1SBN 050 010 R1003	2	0.015
UA 16 to UA 30	24 ... 50	RC 5-1/50	1SBN 050 100 R1000	2	0.012
	50 ... 133	RC 5-1/133	1SBN 050 100 R1001	2	0.012
	110 ... 250	RC 5-1/250	1SBN 050 100 R1002	2	0.012
	250 ... 440	RC 5-1/440	1SBN 050 100 R1003	2	0.012
UA 50 to UA 110	24 ... 50	RC 5-2/50	1SBN 050 200 R1000	2	0.015
	50 ... 133	RC 5-2/133	1SBN 050 200 R1001	2	0.015
	110 ... 250	RC 5-2/250	1SBN 050 200 R1002	2	0.015
	250 ... 440	RC 5-2/440	1SBN 050 200 R1003	2	0.015

UA... 3-pole Contactors for Capacitor Switching

Peak Current $\hat{I} \leq 100$ Times the rms Current



Terminal Marking and Positioning

Standard devices without addition of auxiliary contacts

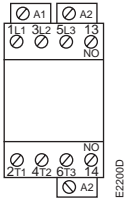

UA16 ... UA30-30-10

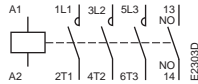

UA16 ... UA30-30-10

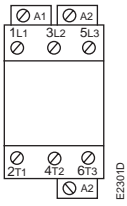

UA50 ... UA110-30-00

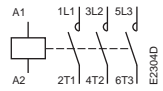

UA50... UA110-30-00

Standard devices with factory mounted auxiliary contacts

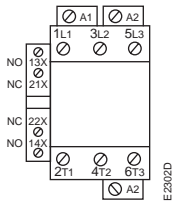

UA50 ... UA110-30-11

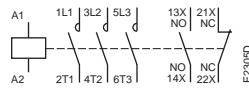

UA50... UA110-30-11

UA... 3-pole Contactors for Capacitor Switching

Peak Current $\hat{I} \leq 100$ Times the rms Current



Dimensions (in mm)

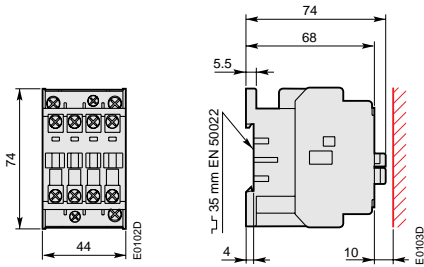

UA 16

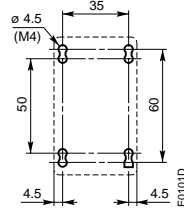

UA 16 drilling plan

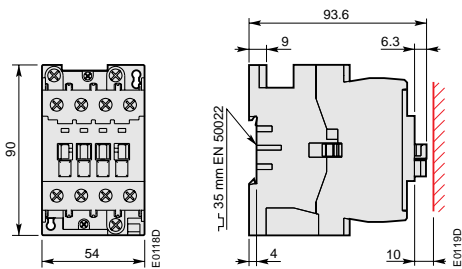

UA 26

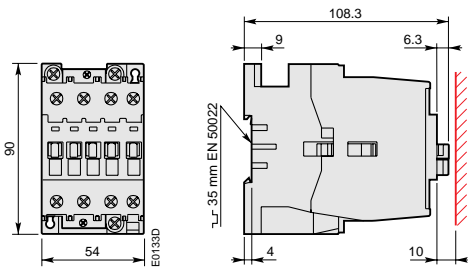

UA 30

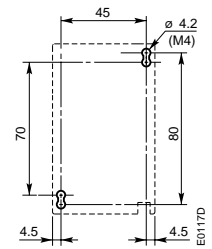

UA 26, UA 30 drilling plan

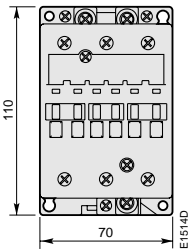

UA 50, UA 63, UA 75-30-00

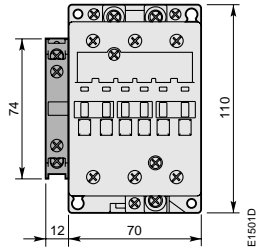

UA 50, UA 63, UA 75-30-11

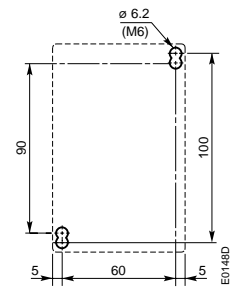
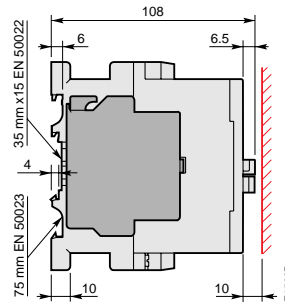

Drilling plan

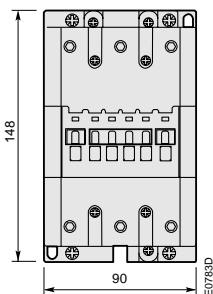

UA 95, UA 110-30-00

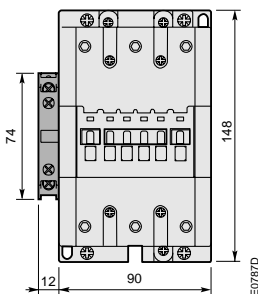

UA 95, UA 110-30-11

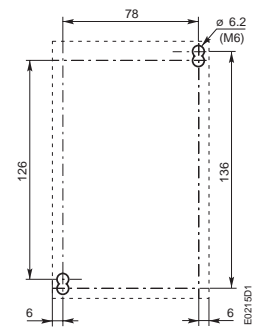
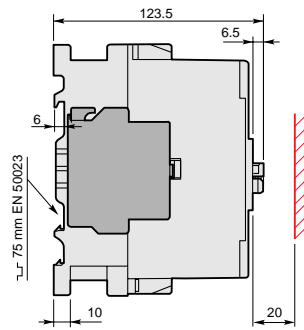

Drilling plan

Detailed dimension drawings available in DXF and PDF formats.

A... Standard 3-pole Contactors for Capacitor Switching

Peak Current $\hat{I} \leq 30$ Times the rms Current
(Single step)



Application

The **A...** and **AF...** contactors are suited for capacitor bank switching for the peak current and power values in the table below.
The capacitors must be discharged (maximum residual voltage at terminals ≤ 50 V) before being re-energized when the contactors are making.
In these conditions, electrical durability of contactors is equal to 100 000 operating cycles.

Description [↔ Main Catalogue.](#)

Selection Table

Type	Powers in kvar 50/60 Hz (AC - 6b)												Max. peak current \hat{I} (kA)			
	220/240 V			400 V			415/440 V			500/550V				690 V		
	40 °C	55 °C	70 °C	40 °C	55 °C	70 °C	40 °C	55 °C	70 °C	40 °C	55 °C	70 °C	40 °C	55 °C	70 °C	
A 9	–	–	–	–	–	–	–	–	–	–	–	–	–	–	–	–
A 12	7	7	6	11	11	9.5	12	12	10.5	14	14	12	19	19	16.5	0.7
A 16	7.5	7.5	6	12.5	12.5	10	14	14	10.5	15.5	15.5	12	21.5	21.5	16.5	1
A 26	11.5	11.5	9	19	19	15	20	20	16.5	23	23	19	32	32	26	1.6
A 30	13	13	11	22	22	18.5	24	24	20.5	28	28	23	38	38	32	1.9
A 40	15	15	12	26	26	20	29	29	22	35	35	25	46	46	34.5	2.1
A 50	22	22	20	38	38	34	42	42	37	48	48	42	65	65	58.5	2.3
A 63	25	25	23	43	43	39	47	47	42.5	54	54	48.5	74	74	67	2.5
A 75	28	28	24.5	48	48	41	52	52	45	60	60	51	82	82	70	2.6
A 95	35	35	33	60	60	53	63	63	58	75	75	70	80	80	75	4
A 110	40	40	35	70	70	60	75	75	65	83	83	78	90	90	85	4
A 145	50	50	42	90	90	74	93	93	80	110	110	96	110	110	110	4
A 185	60	60	45	105	105	78	115	115	85	135	135	102	135	135	135	5
A 210	75	75	57	125	125	100	135	135	110	160	160	130	160	160	160	6.5
A 260	85	85	70	140	140	130	155	155	140	180	180	165	200	200	200	8
A 300	100	100	85	160	160	150	180	180	163	210	210	196	240	240	240	8
AF 400	120	120	105	200	200	185	220	220	200	260	260	241	300	300	300	10
AF 460	140	140	120	230	230	215	260	260	230	325	325	300	325	325	325	10
AF 580	170	170	160	270	270	260	300	300	290	350	350	340	440	440	440	12
AF 750	220	220	190	390	370	332	410	410	380	490	480	435	600	600	600	12

If, in an application, the current peak is greater than the maximum peak current \hat{I} specified in the table above, select a higher rating, refer to the **UA...** contactors, or add inductances. [↔ "Calculation and Dimensioning"](#).

Specific Technical Data - For other characteristics [↔ Main Catalogue.](#)

Short-circuit protection: gG type fuses sized 1.5 ... 1.8 I_n of the capacitor
Electrical durability AC-6b: 100 000 operating cycles

Terminal Marking and Positioning [↔ Main Catalogue.](#)

Dimensions [↔ Main Catalogue.](#)

A... Standard 3-pole Contactors for Capacitor Switching

Peak Current $\hat{I} \leq 30$ Times the rms Current



A 50-30-00



A 95-30-00



AF 750-30-11

Ordering Details

Power 400 V 40 °C kvar	Max. peak current \hat{I} kA	Auxiliary contacts fitted	Type	Order code	Weight kg
			state coil voltage $\square\square$ (see table below)	state coil voltage code $\square\square$ (see table below)	Pack ^{ing} 1 piece
11	0.7	1 -	A 12-30-10 $\square\square$	1SBL 161 001 R $\square\square$ 10	0.340
12.5	1	1 -	A 16-30-10 $\square\square$	1SBL 181 001 R $\square\square$ 10	0.340
19	1.6	1 -	A 26-30-10 $\square\square$	1SBL 241 001 R $\square\square$ 10	0.600
22	1.9	1 -	A 30-30-10 $\square\square$	1SBL 281 001 R $\square\square$ 10	0.710
26	2.1	1 -	A 40-30-10 $\square\square$	1SBL 321 001 R $\square\square$ 10	0.710
38	2.3	- - 1 1	A 50-30-00 $\square\square$ A 50-30-11 $\square\square$	1SBL 351 001 R $\square\square$ 00 1SBL 351 001 R $\square\square$ 11	1.160 1.200
43	2.5	- - 1 1	A 63-30-00 $\square\square$ A 63-30-11 $\square\square$	1SBL 371 001 R $\square\square$ 00 1SBL 371 001 R $\square\square$ 11	1.160 1.200
48	2.6	- - 1 1	A 75-30-00 $\square\square$ A 75-30-11 $\square\square$	1SBL 411 001 R $\square\square$ 00 1SBL 411 001 R $\square\square$ 11	1.160 1.200
60	4	- - 1 1	A 95-30-00 $\square\square$ A 95-30-11 $\square\square$	1SFL 431 001 R $\square\square$ 00 1SFL 431 001 R $\square\square$ 11	2.000 2.040
70	4	- - 1 1	A 110-30-00 $\square\square$ A 110-30-11 $\square\square$	1SFL 451 001 R $\square\square$ 00 1SFL 451 001 R $\square\square$ 11	2.000 2.040
90	4	1 1	A 145-30-11 $\square\square$	1SFL 471 001 R $\square\square$ 11	3.500
105	5	1 1	A 185-30-11 $\square\square$	1SFL 491 001 R $\square\square$ 11	3.500
125	6.5	1 1	A 210-30-11 $\square\square$	1SFL 511 001 R $\square\square$ 11	6.100
140	8	1 1	A 260-30-11 $\square\square$	1SFL 531 001 R $\square\square$ 11	6.100
160	8	1 1	A 300-30-11 $\square\square$	1SFL 551 001 R $\square\square$ 11	6.100
200	10	1 1	AF 400-30-11 $\square\square$	1SFL 577 001 R $\square\square$ 11	12.00
230	10	1 1	AF 460-30-11 $\square\square$	1SFL 597 001 R $\square\square$ 11	12.00
270	12	1 1	AF 580-30-11 $\square\square$	1SFL 617 001 R $\square\square$ 11	15.00
390	12	1 1	AF 750-30-11 $\square\square$	1SFL 637 001 R $\square\square$ 11	15.00

Coil voltages and codes: A 12 ... A 300

Voltage $\square\square$ V - 50Hz	Voltage $\square\square$ V - 60Hz	Code $\square\square$
24	24	8 1
48	48	8 3
110	110 ... 120	8 4
220 ... 230	230 ... 240	8 0
230 ... 240	240 ... 260	8 8
380 ... 400	400 ... 415	8 5
400 ... 415	415 ... 440	8 6

☞ Other voltages, consult page 0/1 of the main catalogue.

Coil voltages and codes: AF 400 ... AF 750

Voltage $\square\square$ V - 50Hz	Voltage $\square\square$ V d.c.	Code
-	24 ... 60	6 8 (1)
48 ... 130	48 ... 130	6 9
100 ... 250	100 ... 250	7 0

(1) The connection polarities indicated close to the coil terminals must be respected: **A1** for the **positive** pole and **A2** for the **negative** pole.

AF... contactors with electronic coil interface: electromagnetic compatibility and A or B environment definitions ☞ Main Catalogue.

A... Standard 3-pole Contactors for Capacitor Switching

Main Accessories



Ordering Details

Auxiliary contact blocks (for other configurations and fitting details ⇨ Main Catalogue)

For contactors	Number of blocks	Contacts blocks	Type	Order code	Pack ^{ing} pieces	Weight kg
						1 piece

1-pole auxiliary contact blocks (Front mounting)

A 12 to A 26	4 blocks	<table border="0"> <tr><td>{</td><td>1</td><td>-</td><td>-</td><td>-</td></tr> <tr><td></td><td>-</td><td>1</td><td>-</td><td>-</td></tr> </table>	{	1	-	-	-		-	1	-	-	CA 5-10	1SBN 010 010 R1010	10	0.014
{	1		-	-	-											
	-		1	-	-											
A 30, A 40	5 blocks	CA 5-01	1SBN 010 010 R1001	10	0.014											
A 50 to A 110	6 blocks															

2-pole auxiliary contact blocks N.O. + N.C. (Side mounting)

A 12 to A 75	2 blocks	1	1	-	-	CAL 5-11	1SBN 010 020 R1011	2	0.050	
A 95, A 300	2 blocks	}	1	1	-	-	CAL 18-11	1SFN 010 720 R1011	2	0.050
AF 400, AF 750	2 blocks									
A 145, A 300	2 blocks (1)	}	1	1	-	-	CAL 18-11B	1SFN 010 720 R3311	2	0.050
AF 400, AF 750	2 blocks (1)									

(1) 2 blocks CAL 18-11 + 2 blocks CAL 18-11B

Surge suppressors for contactor coils

For contactors	Control voltage	Type	Order code	Pack ^{ing} pieces	Weight kg
	V a.c.				1 piece
A 12 to A 110	24 ... 50	RV 5/50	1SBN 050 010 R1000	2	0.015
	50 ... 133	RV 5/133	1SBN 050 010 R1001	2	0.015
	110 ... 250	RV 5/250	1SBN 050 010 R1002	2	0.015
	250 ... 440	RV 5/440	1SBN 050 010 R1003	2	0.015
A 12 to A 40	24 ... 50	RC 5-1/50	1SBN 050 100 R1000	2	0.012
	50 ... 133	RC 5-1/133	1SBN 050 100 R1001	2	0.012
	110 ... 250	RC 5-1/250	1SBN 050 100 R1002	2	0.012
	250 ... 440	RC 5-1/440	1SBN 050 100 R1003	2	0.012
A 50 to A300	24 ... 50	RC 5-2/50	1SBN 050 200 R1000	2	0.015
	50 ... 133	RC 5-2/133	1SBN 050 200 R1001	2	0.015
	110 ... 250	RC 5-2/250	1SBN 050 200 R1002	2	0.015
	250 ... 440	RC 5-2/440	1SBN 050 200 R1003	2	0.015

Note: for AF 400 ... AF 750 the built-in coil interface eliminates the need of extra surge suppressors.



CA 5-10



CAL 5-11



RV 5/50



RC 5-1/50

Contactors for Capacitor Switching

Selection Examples

Application and Possibilities

Description of the application

Capacitor bank:

20 kvar at 400 V, 50 Hz three-phase.

Ambient temperature around the contactor: 40 °C

Nominal current:
$$I_n = \frac{P}{\sqrt{3} \times U}$$

$$= \frac{20000}{1.7 \times 400} \approx 29 \text{ A}$$

Thermal current:
$$I_T = I_n \times 1.5$$

$$= 29 \times 1.5 \approx 43 \text{ A}$$

Case no. 1 - Inrush peak current: 1700 Å

Possibility selection table for A... standard contactors ☞ page 16

A 30 contactor (22 kvar, 380/400 V).

This contactor accepts a maximum peak current of 1900 Å.

Case no. 2 - Inrush peak current: 2500 Å

Possibility no. 1 selection table for UA... contactors ☞ page 10

UA 26 contactor (20 kvar, 400 V). This contactor accepts a maximum peak current of 3000 Å ($U_e \leq 500V$).

Possibility no. 2 selection table for A... standard contactors ☞ page 16

A 30 contactor + additional inductances limiting peak current to a peak of 1900 Å that is acceptable for the A 30 contactor.

Possibility no. 3 selection table for A... standard contactors ☞ page 16

A 63 contactor (43 kvar, 400 V).

This contactor accepts a maximum peak current of 2500 Å.

Case no. 3 - Inrush peak current: 4500 Å.

Possibility no. 1 selection table for UA..RA contactors ☞ page 4

UA 26..RA contactor (22 kvar, 400 V).

This contactor can be directly used without an additional inductance.

Possibility no. 2 selection table for UA... contactors ☞ page 10

UA 26 contactor + additional inductances limiting peak current to a peak of 3000 Å acceptable for the UA 26 contactor ($U_e \leq 500 V$).

Possibility no. 3 selection table for A... standard contactors ☞ page 16

A 30 contactor + additional inductances limiting peak current to a peak of 1900 Å acceptable for the A30 contactor.

Possibility no. 4 selection table for A... standard contactors ☞ page 16

A 185 contactor (105 kvar 400 V).

This contactor accepts a maximum peak current of 5000 Å.



The information given on pages 20 and 21 will enable the user to calculate current peaks and to limit them to a value acceptable for the contactor. Since this calculation is never exact, capacitor bank manufacturers optimise their products by tests.

Calculation of Inrush Current Peak and Frequency

If the inrush current peak on energizing of a capacitor bank is greater than that acceptable for the switching contactor, there is a risk that power factor correction will no longer be ensured.

This is because, in this case, the contactor may remain permanently closed due to welding of its main poles.

The formulas given below are used to estimate inrush current peak as well as current frequency during the transient period. The values of the inductances used in the formulas can be determined by the methods described on pages 22 and 23.

Caution:

These formulas are applicable only if the capacitor bank is completely discharged at the time of energizing (maximum voltage at terminals ≤ 50 V).

Three-phase Capacitor Bank with a Single Step.

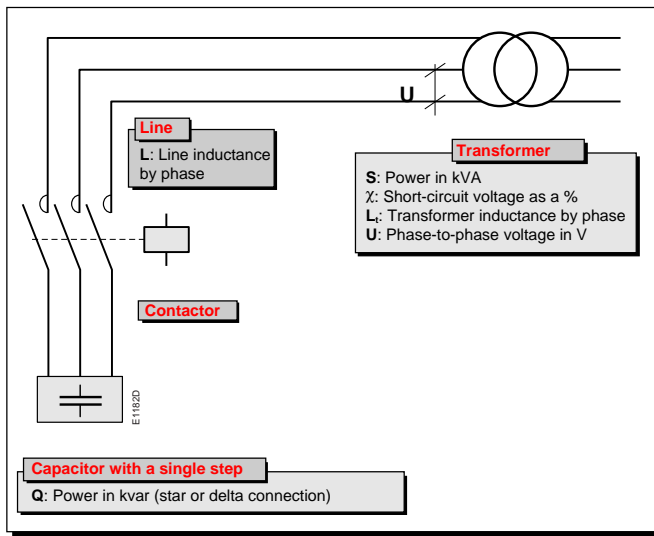

Inrush peak current \hat{I} :

$$\hat{I} = \sqrt{\frac{10^9}{3 \pi f}} \times \sqrt{\frac{Q}{L + L_t}} \quad \hat{I} = k_1 \sqrt{\frac{Q}{L + L_t}}$$

Inrush current frequency f_0 :

$$f_0 = k_2 U \sqrt{\frac{1}{Q(L + L_t)}}$$

\hat{I} : in Amperes
f: mains current frequency in Hz
Q: in kvar
L, Lt in μ H
k₁ = 1457 (50 Hz) or 1330 (60 Hz)
k₂ = 89.2 (50 Hz) or 97.2 (60 Hz)

Three-phase Capacitor Bank with Several Steps of Identical Power.

Energizing of the capacitor Q_n with "n - 1" capacitors on duty.

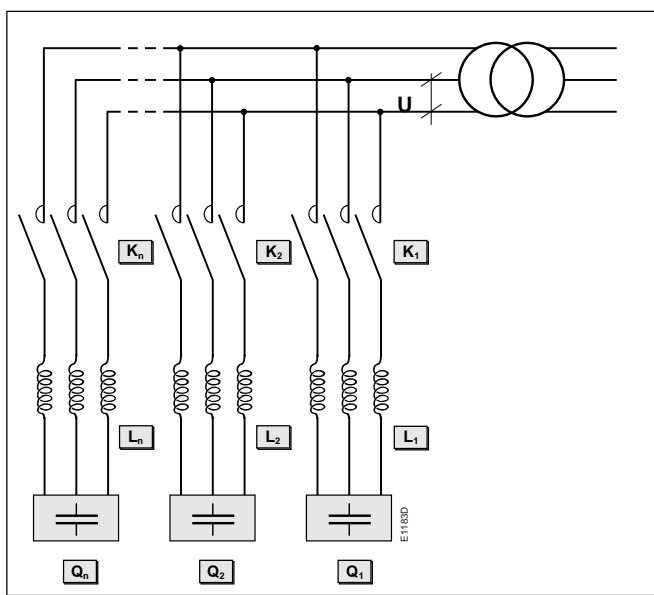

Inrush peak current \hat{I} :

$$\hat{I} = k_1 \frac{n-1}{n} \times \sqrt{\frac{Q_n}{L_n}}$$

Inrush current frequency f_0 :

$$f_0 = k_2 U \sqrt{\frac{1}{L_n \times Q_n}}$$

\hat{I} : in Amperes
L₁ = L₂ = L_{...} = L_n: inductance by phase of a step in μ H
Q₁ = Q₂ = Q_{...} = Q_n: power of a step in kvar
n: number of capacitor steps
U: phase-to-phase voltage in V
k₁ = 1457 (50 Hz) or 1330 (60 Hz)
k₂ = 89.2 (50 Hz) or 97.2 (60 Hz)

Calculation of Inrush Current Peak and Frequency

Three-phase Capacitor Bank with Several Steps of Different Powers

Energizing of the capacitor Q_n with "n - 1" capacitors on duty

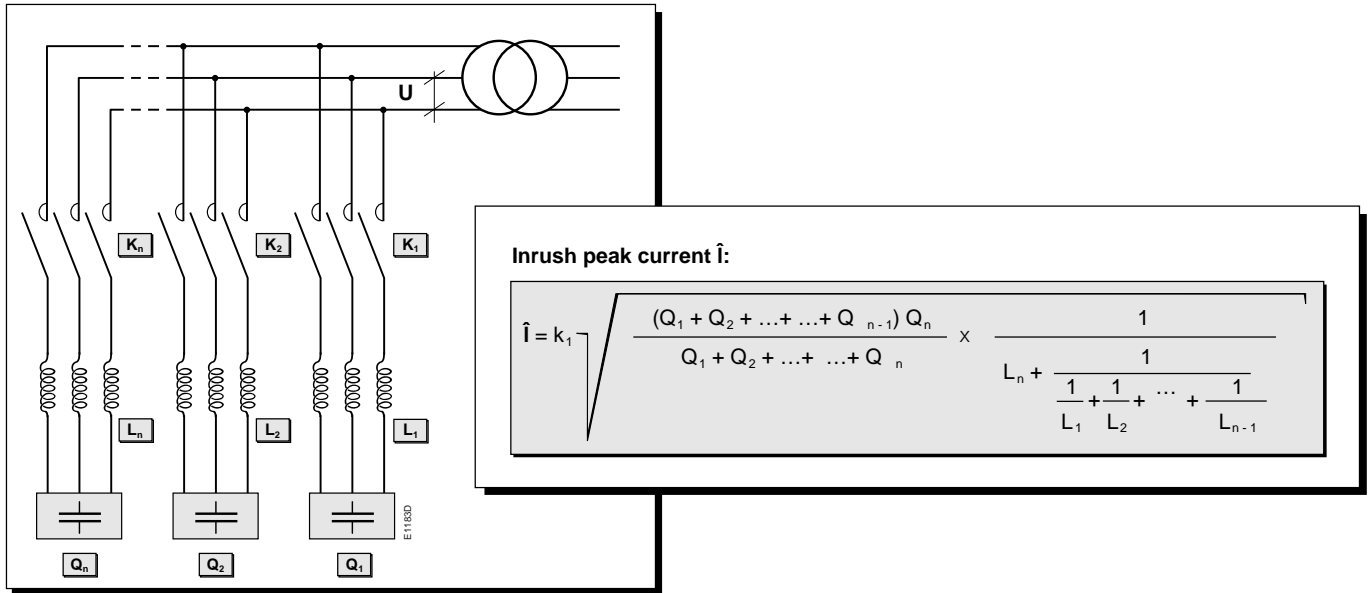

Energizing of Q_n

– Fictitious number of steps $n = \frac{\text{Bank total power}}{\text{Power of smallest step}}$

– The inrush current peak of Q_n is the same as that of a capacitor bank made up of n identical steps provided that the inductances L_1, L_2, \dots, L_n are inversely proportional to the power of these steps.

$$L_n \text{ mini} = L_1 \frac{Q_1}{Q_n}$$

$Q_1 = a Q_n$	$L_1 = L_n / a$
$Q_2 = b Q_n$	$L_2 = L_n / b$
$Q_{..} = .. Q_n$	$L_{..} = L_n / ..$
↓	↓
$Q_{n-1} = z Q_n$	$L_{n-1} = L_n / z$

Determining the Transformer Inductance

The value of the inductance (L_t) of the transformer used in the various formulas above can be determined by following the method described below.

● **Reminder of the values marked on the transformer plate**

- S:** Power in kVA
- χ :** Short-circuit voltage as a %
- U:** Phase-to-phase operating voltage in Volts
- f:** Current frequency in Hertz

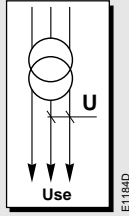

Value L_t of the inductance by phase of the transformer in μH :

$$L_t = \frac{1}{200 \pi f} \cdot \frac{\chi U^2}{S} \cdot 10^3$$

$$L_t = \frac{\chi U^2}{k_3 S}$$

$k_3 = 31.4$ (50 Hz) or 37.68 (60 Hz)

The following chart gives this value by direct reading

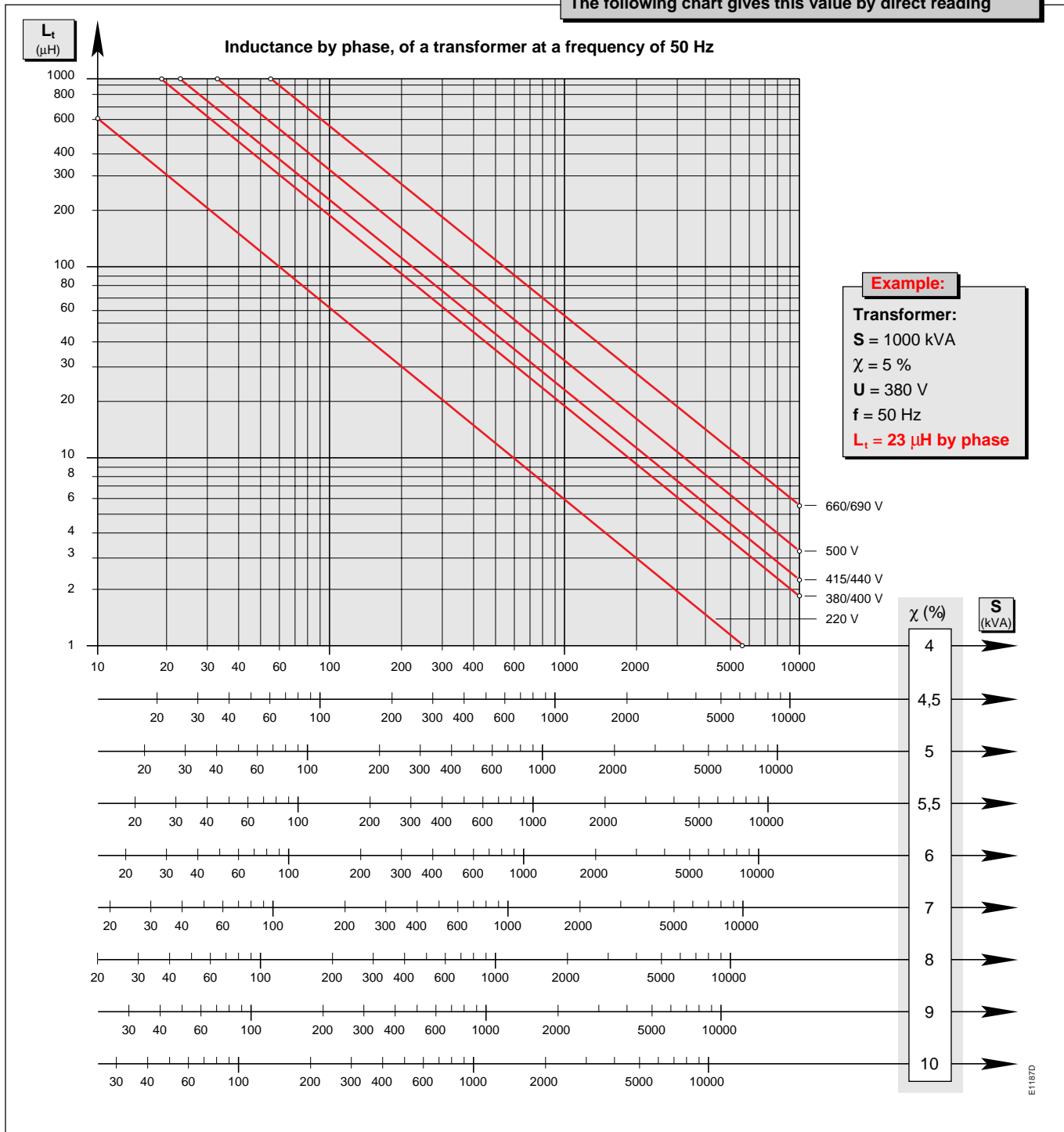

Determining the Electrical Connection Inductances

For a symmetrical connection formed by non-magnetic conductors, the linear coefficient of apparent self-inductance is the same for all the conductors and is given by:

$$L = \left[0.05 + 0.46 \log_{10} \frac{2 a_m}{d} \right] \mu\text{H/m}$$

d = diameter of the conductive core (mm)

a_m = geometric average of distances between the conductor axes (mm)

Single-phase installation

$$a_m = a$$

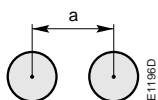

Three-phase delta installation

$$a_m = a$$

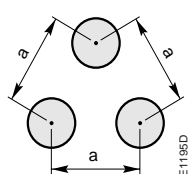

Three-phase adjacent installation

$$a_m = a \sqrt[3]{2}$$

$$a_m = 1.26 a$$

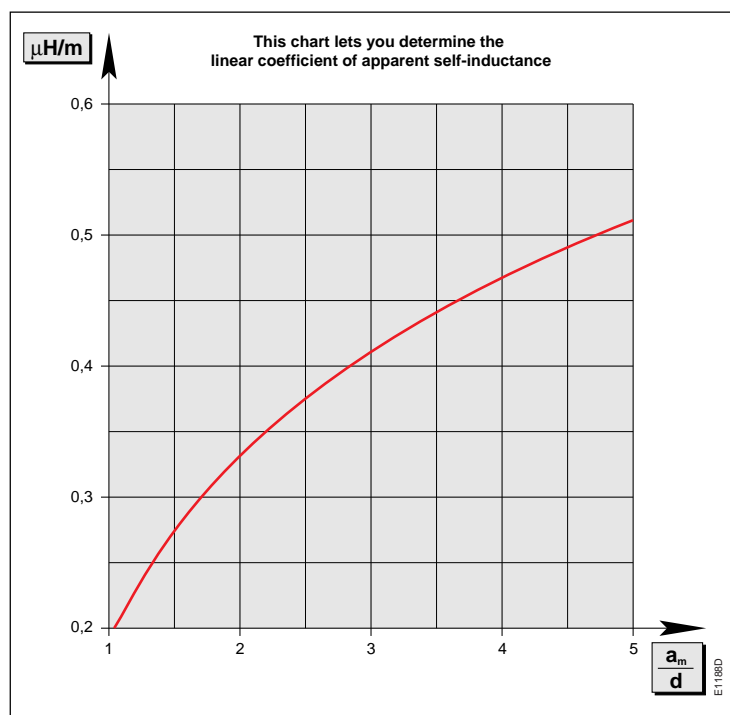
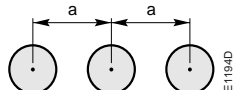

Guideline values

Conductive cross-sectional area (mm ²)	4	6	10	16	25	35	50	70	95	120
Conductive core $\varnothing = d$ (mm)	2.26	2.92	3.9	4.9	6.1	7.2	8.4	10.1	11.9	13.4
Outer \varnothing U1000 RO2V	7.2	8.2	9.2	10.5	12.5	13.5	15	17	19	21

Attenuation of the Inrush Peak

If the electrical connection inductances are very low, the inrush current peak of the capacitor bank may not be sufficiently attenuated and thus cause welding of the main poles of the contactor.

To avoid this risk, the user must select a contactor that can withstand a higher current peak (UA or UA..RA range) or may serial-connect "additional" inductances in the circuit.

Determining Electrical Connection Minimum Inductances

The formulas given on page 20 to calculate the inrush current peak can also be used to determine the minimum value of the electrical connection inductances separating the transformer from the capacitor bank, without risk of welding the main poles of the contactor.

● Capacitor bank with one step

$$\hat{I} = k_1 \sqrt{\frac{Q}{L + L_t}} \quad \text{thus } L_{\min} = \left(\frac{k_1^2}{\hat{I}^2} Q \right) - L_t$$

L_{\min} : minimum inductance of the electrical connection in μH .

\hat{I} : maximum peak, acceptable for the contactor in **A** (see tables on pages 10 and 16).

Q: power of the capacitor bank in **kvar**.

Q_n : power of the n^{th} step in **kvar**.

L_t : inductance by phase of the transformer in μH .

$k_1 = 1457$ (if $f = 50 \text{ Hz}$) or $= 1330$ (if $f = 60 \text{ Hz}$)

● Capacitor bank with several identical steps

$$\hat{I} = k_1 \frac{n-1}{n} \sqrt{\frac{Q_n}{L_n + L_t}} \quad \text{thus } L_{\min} = \left(\frac{k_1^2}{\hat{I}^2} \frac{(n-1)^2}{n^2} Q_n \right) - L_t$$

The chart on page 25 allows, by direct reading, identification of the minimum value of the inductance according to:

- the type of contactor,
- the power of the capacitor bank in kvar,
- the number of steps.

Practical Method for Making Additional Inductances

If the electrical connection inductances are too low (current peaks not sufficiently attenuated), the user can add additional inductances, simply made by winding the cables designed to be connected to the capacitor bank, onto a cylinder. The method below provides all the technical information required to make these additional inductances.

● Theoretical reminder

An electrical conductor wound with j joining turns on a cylinder of a diameter (d), forms an inductance coil whose inductance is equal to:

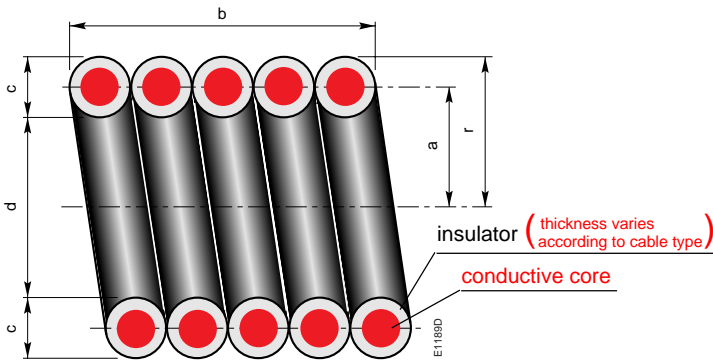

$$L = 10^{-7} \frac{4 \pi^2 \cdot a^2 \cdot N^2}{b + c + r} \cdot F_1 \cdot F_2$$

$$F_1 = \frac{10 b + 12 c + 2 r}{10 b + 10 c + 1,4 r}$$

$$F_2 = 0.5 \log_{10} \left(100 + \frac{14 r}{2 b + 3 c} \right)$$

L: self-inductance in **H**

N: number of circular turns

a, b, c, d, r: dimensions in **m**

● Charts

The charts on pages 26 and 27 allow, by direct reading, identification of the number of turns to be made according to:

- the cable cross-sectional area that will be used to connect the capacitor bank,
- the diameter of the cylinder used to make the inductance coil,
- the necessary inductance value.

Attenuation of the Inrush Peak

Chart used to determine electrical connection minimum inductances

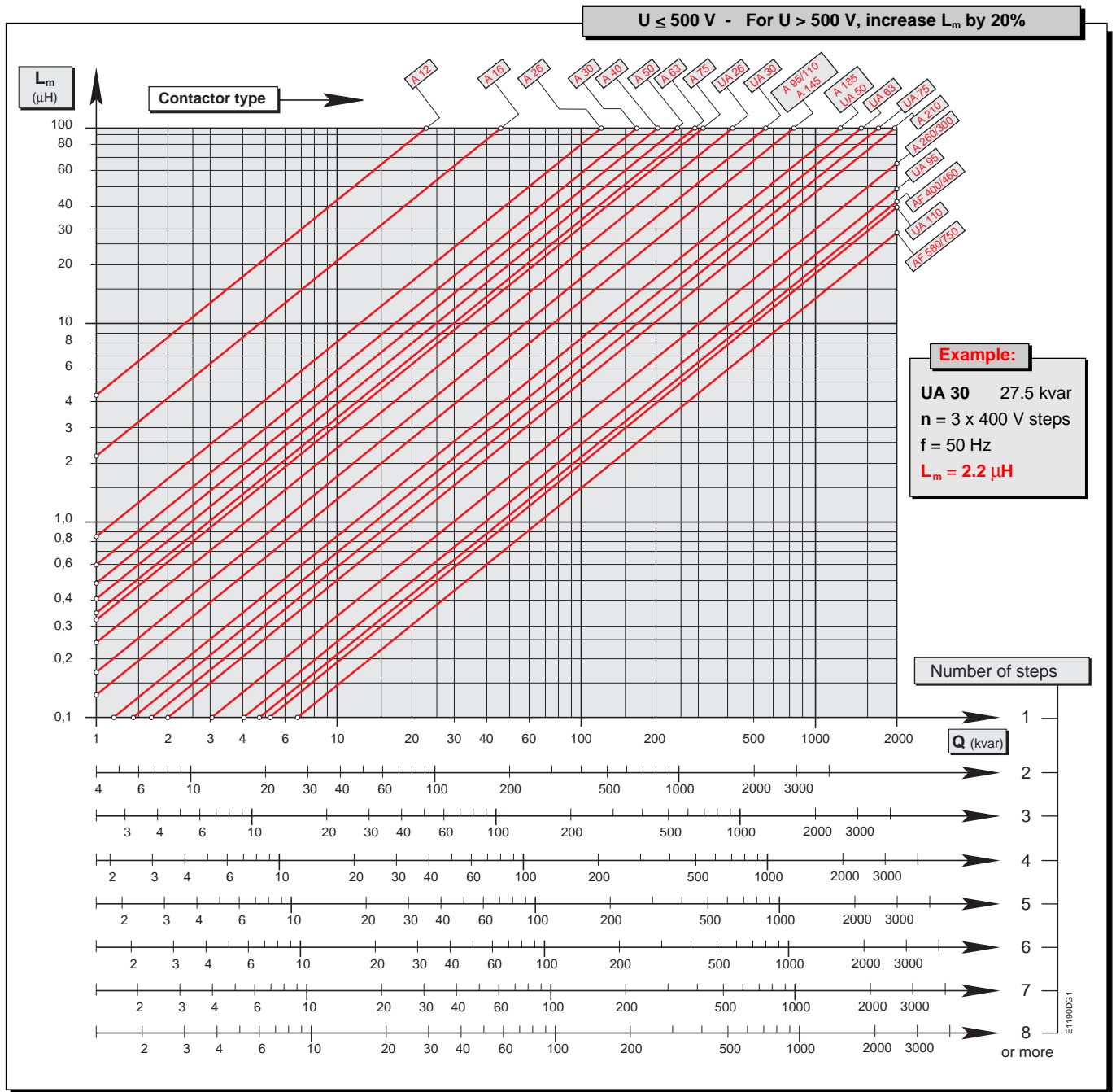

Attenuation of the Inrush Peak

Additional Inductances ($\varnothing = 10 \times$ cable diameter)

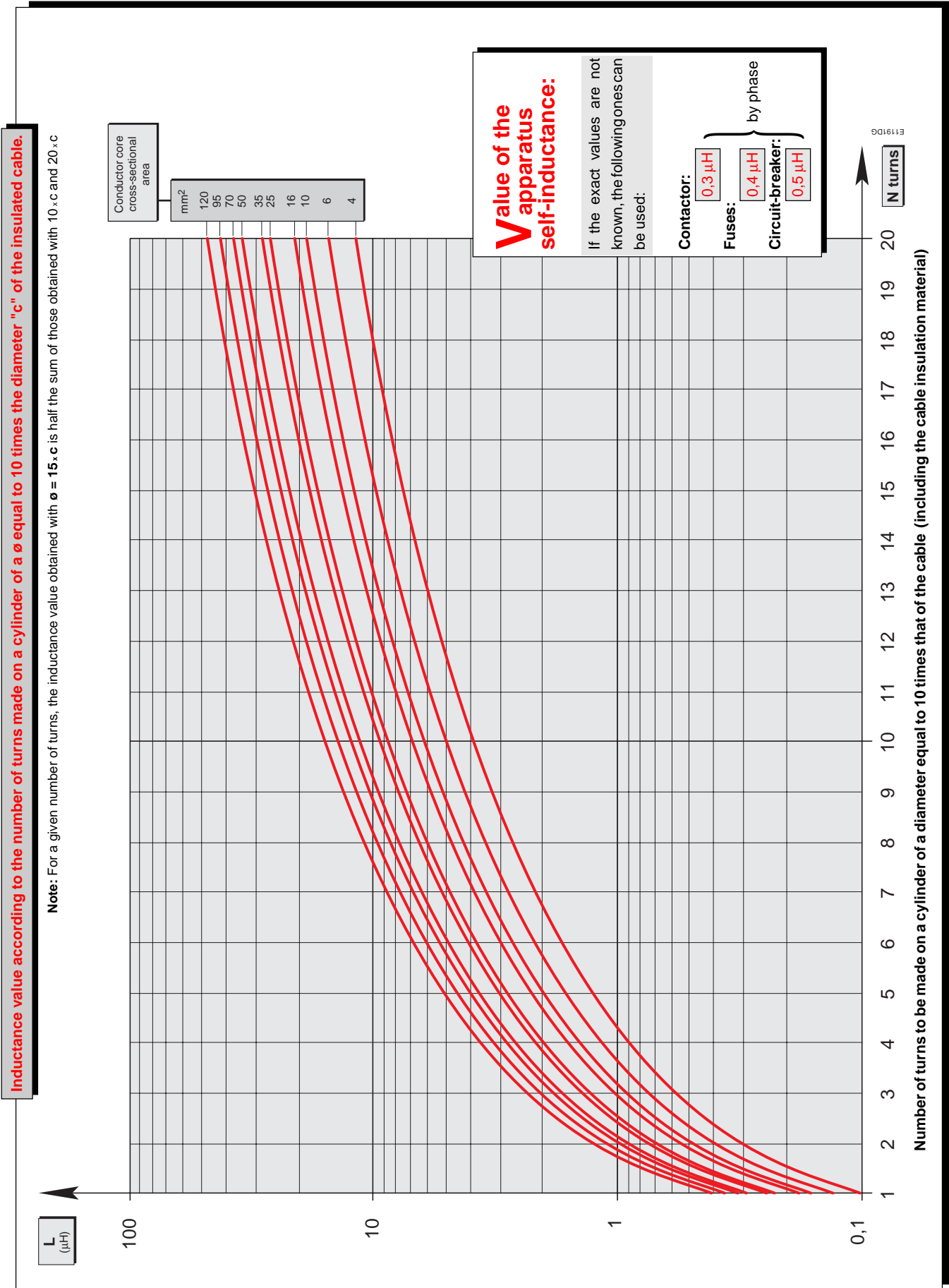

Attenuation of the Inrush Peak

Additional Inductances ($\emptyset = 20 \times$ cable diameter)

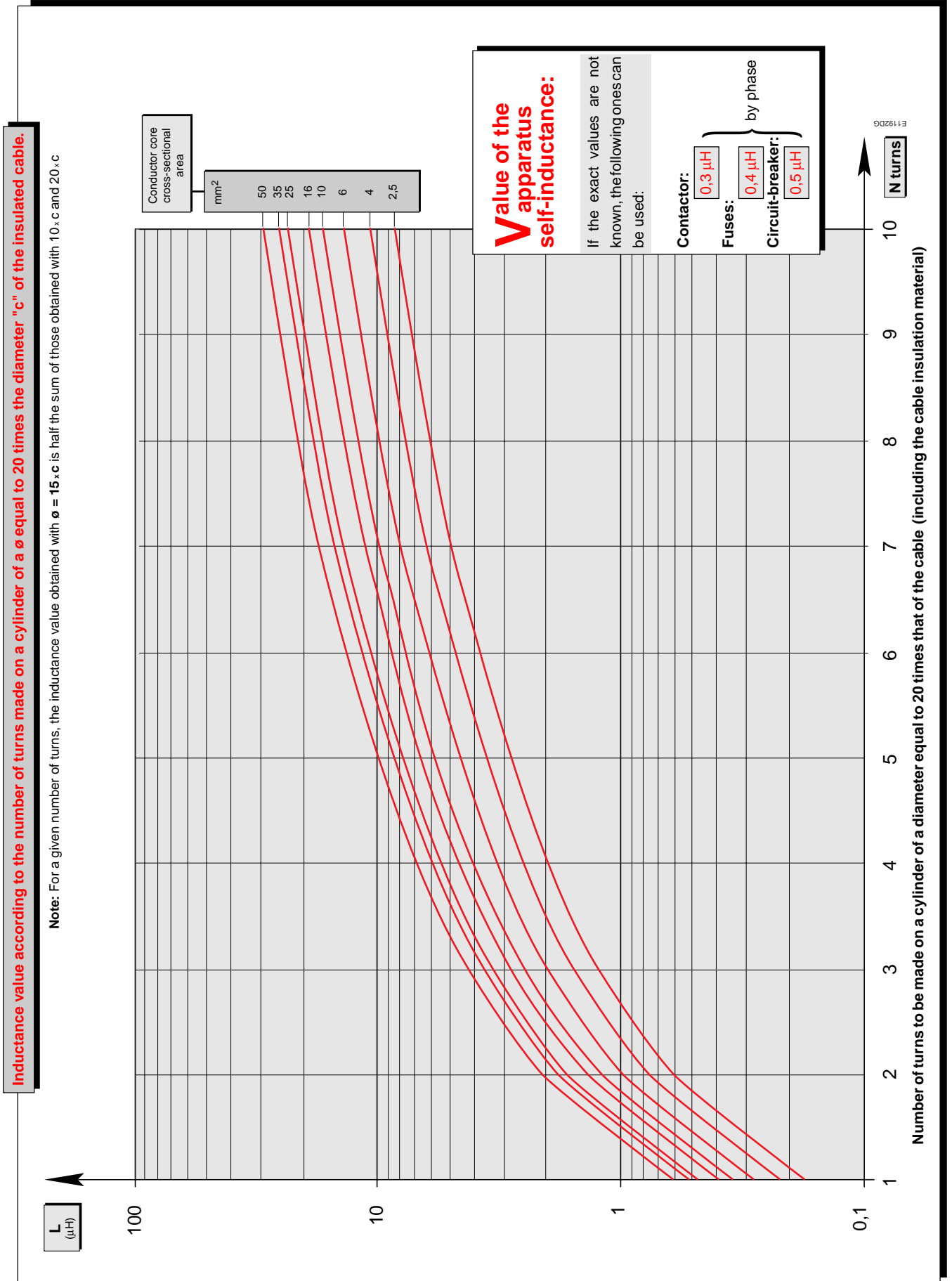

Installation Studies

Three-phase Capacitor Bank with a Single Step

Example:

Transformer.
500 kVA 220 V 50 Hz Short-circuit voltage $\chi = 4\%$
Capacitor = 5 kvar
Transformer/capacitor connection
10 m of adjacent cables $a_m = 3 d$ (4 mm²)
Temperature: $\theta = 55\text{ }^\circ\text{C}$

$$\hat{I} = k_1 \sqrt{\frac{Q}{L + L_t}} \quad (\text{page 20})$$

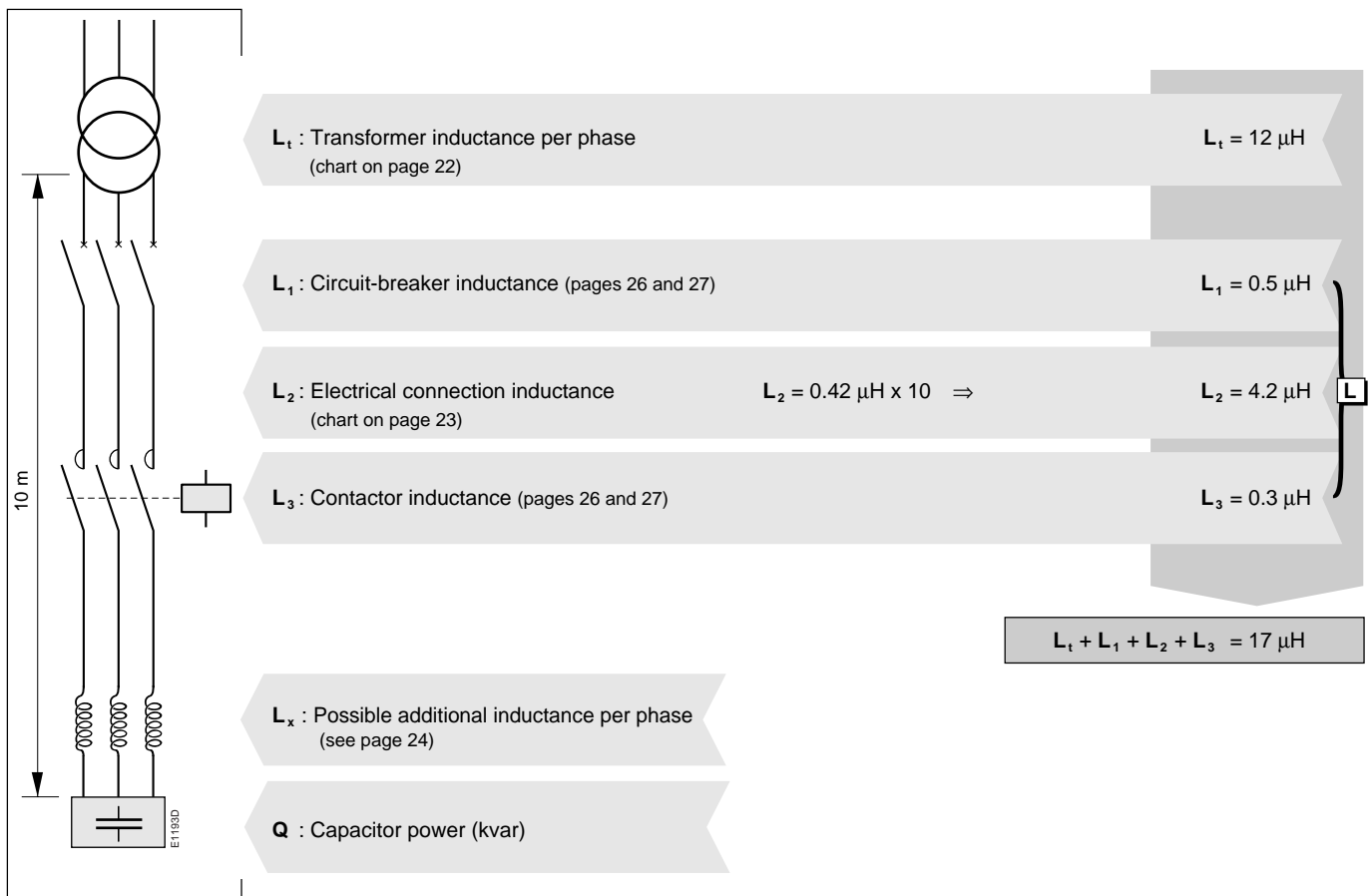

Selecting the contactor (pages 4-10-16)

Type (table on page 16)

A 12

Look for L_m (chart on page 25)

Network minimum inductance

$L_m = 21\ \mu\text{H}$

If $L_m \leq L_t + L_1 + L_2 + L_3 + \dots \Rightarrow$ No additional inductance L_x

If $L_m > L_t + L_1 + L_2 + L_3 + \dots \Rightarrow$ Add an additional inductance L_x such that: $L_x \geq L_m - (L_t + L_1 + L_2 + L_3 + \dots)$

$$L_x \geq 21\ \mu\text{H} - 17\ \mu\text{H} \quad \text{thus } L_x \geq 4\ \mu\text{H}$$

L_x made up of 6 turns per phase of 4 mm² copper cable (as per chart on page 27) $\varnothing = 20\ \text{c}$

If you want to remove or reduce L_x you can choose a contactor with a greater making capacity

If you choose an **A 16** contactor; the chart (on page 25) gives $L_m = 10\ \mu\text{H}$

Thus no additional inductance as $10 < 17\ \mu\text{H}$

Installation Studies

Three-phase Capacitor Bank with Several Steps of Identical Power.

Example:

Transformer.
630 kVA 400 V 50 Hz Short-circuit voltage $\chi = 4\%$

Capacitors: bank with 6 steps of 20 kvar

Connections:
transformer/ capacitors 10 m of adjacent cables $a_m = 4$ d
capacitors/busbars: 0.50 m in delta 10 mm^2 $a_m = 4$ d

Temperature: $\theta = 40^\circ\text{C}$

$$\hat{I} = k_1 \frac{n-1}{n} \sqrt{\frac{Q_n}{L_n}}$$

(page 20)

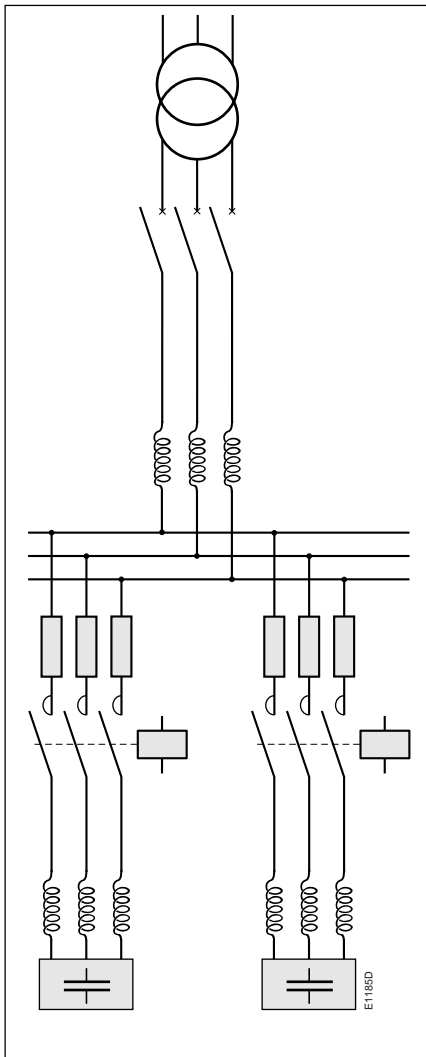

L_1 : Transformer inductance per phase (chart on page 22)	$L_1 = 30 \mu\text{H}$
L_1 : Circuit-breaker inductance (pages 26 and 27)	$L_1 = 0.5 \mu\text{H}$
L_2 : Connection inductance: transformer/capacitor bank by phase (chart on page 23)	$L_2 = 0.47 \mu\text{H} \times 10 \Rightarrow L_2 = 4.7 \mu\text{H}$
L_x : Additional inductance, if necessary, per phase (value 0 for this example). If L_x other than 0, reduce by the same amount the value of the additional inductance L_y below.	
L_3 : Connection inductance: busbar/capacitor, per phase (chart on page 23)	$L_3 = 0.47 \mu\text{H} \times 0.5 \Rightarrow L_3 = 0.24 \mu\text{H}$
L_4 : Fuse inductance (pages 26 and 27)	$L_4 = 0.4 \mu\text{H}$
L_5 : Contactor inductance (pages 26 and 27)	$L_5 = 0.3 \mu\text{H}$
$L_n = L_3 + L_4 + L_5 = 0.94 \mu\text{H}$	
L_y : Additional inductance, if necessary, per phase and per step (page 24)	
Q : Capacitor power (kvar) (n identical steps)	

Selecting the contactor (pages 4-10-16)	Type (table page 10)	UA 26
Look for L_m (chart on page 25)	Network minimum inductance	$L_m = 3.2 \mu\text{H}$
If $L_m \leq L_3 + L_4 + L_5 + \dots \Rightarrow$ No additional inductance L_y		
If $L_m > L_3 + L_4 + L_5 + \dots \Rightarrow$ Add an additional inductance L_y	$L_y = 3.2 \mu\text{H} - 0.94 \mu\text{H}$	$= 2.26 \mu\text{H}$
L_y made up of 3 turns per phase of 10 mm^2 copper cable (as per chart on page 27) $\varnothing = 20$ c		
If you want to eliminate or reduce L_y you can choose a contactor with a higher making capacity.		
If you choose an UA75 contactor; the chart (page 25) gives $L_m = 0.85 \mu\text{H}$ Thus no additional inductances as $0.85 < 0.94 \mu\text{H}$		
The upstream inductance value $L_t + L_1 + L_2 = 35.2 \mu\text{H}$ makes the addition of additional inductances L_x pointless.		

Installation Studies

Three-phase Capacitor Bank with Several Steps of Different Powers.

Example:

Transformer.

400 kVA 400 V 50 Hz Short-circuit voltage $\chi = 4\%$

Capacitors: bank with 3 steps of: 20 kvar, 30 kvar, 50 kvar

Connections:

transformer/busbars: 10 m of adjacent cables $a_m = 4$ d

busbars/capacitors: 1 m $a_m = 4$ d

Temperature: $\theta = 40^\circ\text{C}$

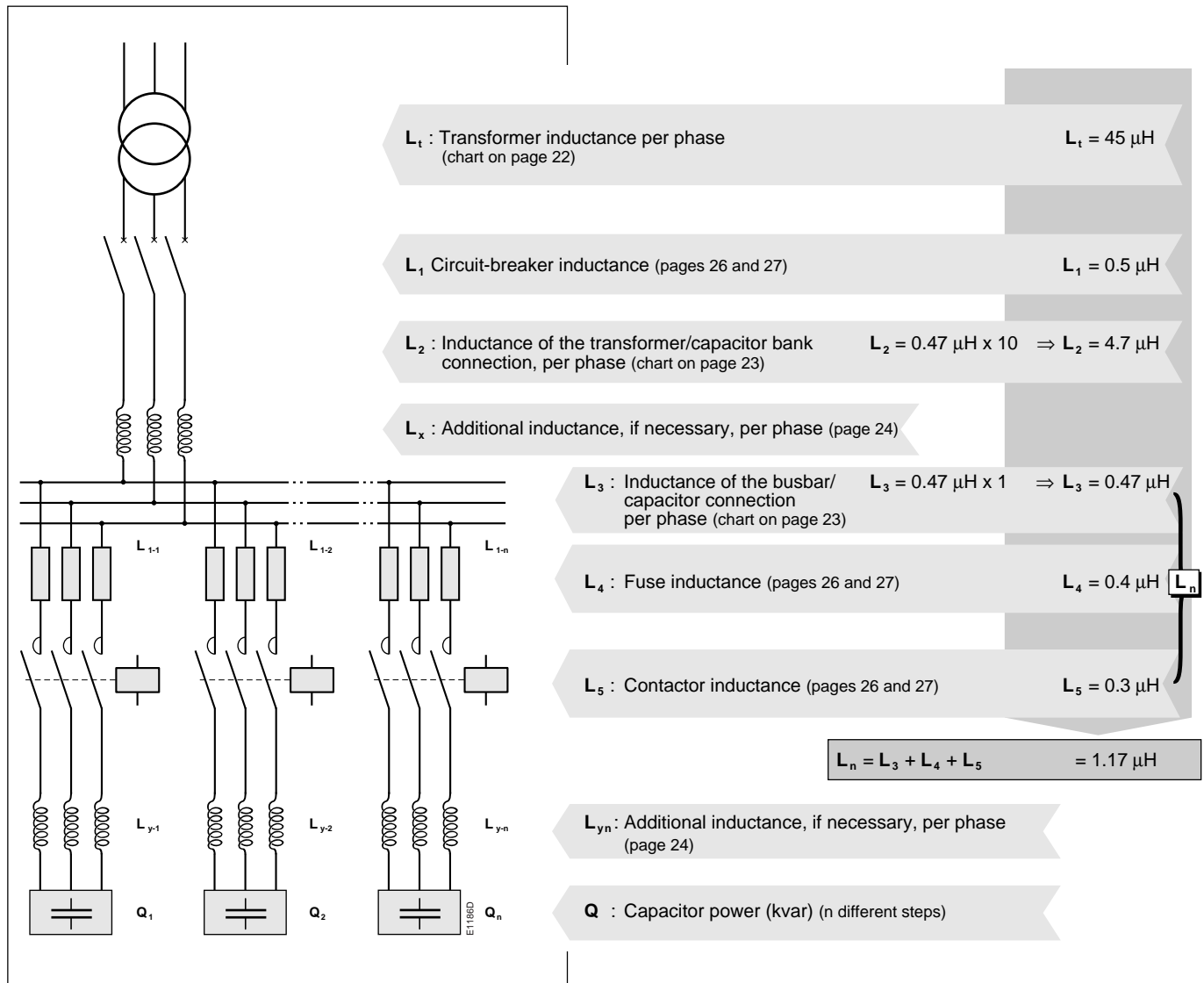

Preselection of contactors (tables on pages 4-10-16)

Type	Smallest step: 20 kvar	⇒	UA 26
(table on page 10)	Step with intermediate power: 30 kvar	⇒	UA 50
	Most powerful step: 50 kvar	⇒	UA 75

Installation Studies

Determining any self-inductances L_y .

Calculate the minimum inductance of the connection of each step, as though the bank were made up of n_p steps of identical power Q_p to that being analysed.

$$n_p = \frac{Q_1 + Q_2 + Q_3 + Q_{\dots} + Q_p + Q_{\dots} + Q_n}{Q_p}$$

Example : $n_1 = \frac{\text{Bank total power}}{\text{Power of smallest step}}$

Smallest step: 20 kvar

Fictitious number of steps: $n_1 = \frac{20 + 30 + 50}{20} = 5$

Preselected **UA 26** contactor (table on page 10)

Minimum inductance for 5 steps of **20 kvar** (chart on page 25): $L_1 = 3 \mu\text{H}$

Additional inductance $L_{y1} = L_1 - L_n$

$L_{y1} = 3 - 1.17 = 1.83 \Rightarrow$ **Additional inductance of 1.83 μH**

The inductances of the other connections must have as their minimum value the one satisfying the **most restrictive** of the 2 requirements below:

Requirement no. 1: Be at least inversely proportional to the powers of each capacitor step, i.e. $L_n \text{ mini} = L_1 \frac{Q_1}{Q_n}$.

Requirement no. 2: Be compatible with the contactor used (chart on page 25).

Step of intermediate power: 30 kvar

Fictitious number of steps: $n_2 = \frac{20 + 30 + 50}{30} \# 3$

Requirement no. 1: $L_2 \text{ min.} = L_1 \frac{Q_1}{Q_2} = 3 \times \frac{20}{30} = 2 \mu\text{H}$.

Requirement no. 2: Preselected **UA 50** contactor (table on page 10)

Minimum inductance for 3 steps of **30 kvar** (chart on page 25): **1.1 μH** .

The most restrictive requirement is $L_2 \text{ min.} = 2 \mu\text{H}$.

Thus, an additional inductance is required

$L_{y2} = 2 \mu\text{H} - 1.17 \mu\text{H} = 0.83 \mu\text{H}$

Most powerful step: 50 kvar

Fictitious number of steps: $n_3 = \frac{20 + 30 + 50}{50} = 2$

Requirement no. 1: $L_3 \text{ min.} = L_1 \frac{Q_1}{Q_3} = 3 \times \frac{20}{50} = 1.2 \mu\text{H}$.

Requirement no. 2: Preselected **UA 75** contactor (table on page 10)

Minimum inductance for 2 steps of **50 kvar** (chart on page 25): **0.7 μH** .

The most restrictive requirement is $L_3 \text{ min.} = 1.2 \mu\text{H}$.

The value of the connection inductance, 1.17 μH , is very close to 1.2 μH , there is thus **no point providing an additional inductance: $L_{y3} = 0$**

The upstream inductance value $L_1 + L_1 + L_2 = 50 \mu\text{H}$ makes the addition of additional inductances L_x pointless.

We could choose all contactors of the same size: the largest preselected rating (UA 75 in our example).

The result would be:

20 kvar step: $n_1 = 5$ \Rightarrow Chart page 25: $L_{1 \text{ min.}} = 0.8 \mu\text{H}$ $\Rightarrow L_n = 1.17 \mu\text{H}$ is greater than L_1 thus $L_{y1} = 0$

30 kvar step: $n_2 = 3$ \Rightarrow Chart on page 25: $L_{2 \text{ min.}} = 0.8 \mu\text{H}$

Checking the other requirement: $L_{2 \text{ min.}} = L_1 \frac{Q_1}{Q_2} = 0.8 \frac{20}{30} = 0.53 \mu\text{H}$

The most restrictive requirement is $L_{2 \text{ min.}} = 0.8 \mu\text{H}$ $\Rightarrow L_n = 1.17 \mu\text{H}$ is greater than L_2 thus $L_{y2} = 0$

50 kvar step: $n_3 = 2$ \Rightarrow Chart on page 25: $L_{3 \text{ min.}} = 0.78 \mu\text{H}$

Checking the other requirement: $L_{2 \text{ min.}} = L_1 \frac{Q_1}{Q_3} = 0.8 \frac{20}{50} = 0.32 \mu\text{H}$

The most restrictive requirement is $L_{2 \text{ min.}} = 0.78 \mu\text{H}$ $\Rightarrow L_n = 1.17 \mu\text{H}$ is greater than L_3 thus $L_{y3} = 0$

Advantage: this choice means that inductances are not to be added.



ABB Entrellec
10, rue Ampère Z.I. - B.P. 114
F-69685 Chassieu cedex / France
Telephone: +33 (0) 4 7222 1722
Telefax: +33 (0) 4 7222 1935
<http://www.abb.com/lowvoltage>

ABB Automation Technology Products AB
S-721 61 Västerås / Sweden

Telephone: +46 (0) 21 32 07 00
Telefax: +46 (0) 21 12 60 01
<http://www.abb.com/lowvoltage>

As part of its on-going product improvement, ABB reserves the right to modify the characteristics or the products described in this document.

The information given is not-contractual. For further details please contact the ABB company marketing these products in your country.